

Aeroprakt Ltd.

24, Polevaya str., Kiev, Ukraine

Tel: 038 044 496-77-21

e-mail: aeroprakt.kiev@gmail.com

www.aeroprakt.kiev.ua

AEROPRAKT-32 (A32L)

Illustrated Parts Catalog

Иллюстрированный каталог частей

A32-(A32L)-IPC-08

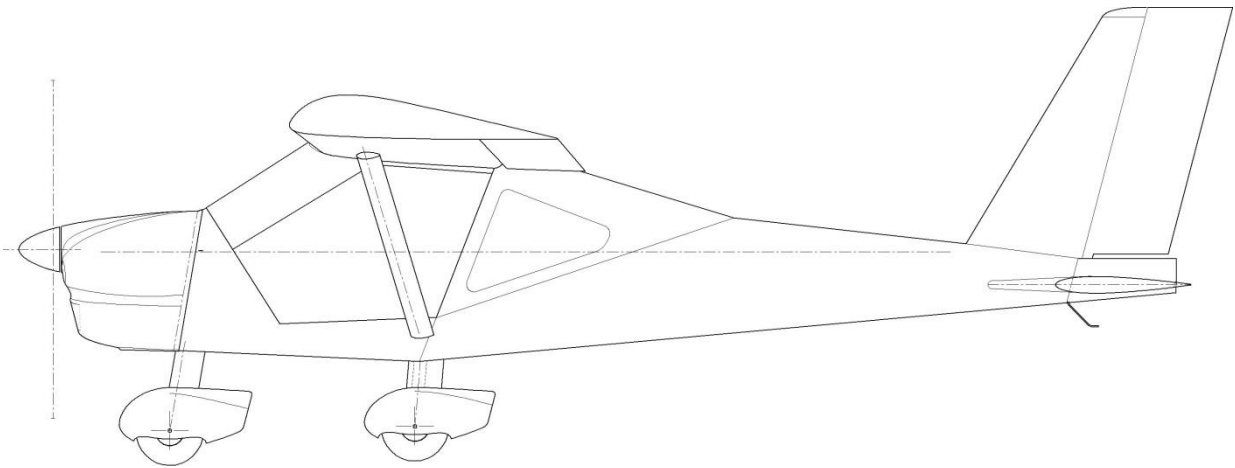

Contents / Содержание

INTRODUCTION / ВВЕДЕНИЕ	3
01. AIRFRAME / ПЛАНЕР	4
FUSELAGE / ФЮЗЕЛЯЖ.....	4
WING / КРЫЛО.....	8
HORIZONTAL EMPENNAGE / ГОРИЗОНТАЛЬНОЕ ОПЕРЕНИЕ	13
VERTICAL EMPENNAGE / ВЕРТИКАЛЬНОЕ ОПЕРЕНИЕ	15
GLASS / ОСТЕКЛЕНИЕ	16
DOORS / ДВЕРИ	17
02. LANDING GEAR / ШАССИ	18
NOSE LEG / ПЕРЕДНЯЯ СТОЙКА.....	18
MAIN LEG / ОСНОВНАЯ СТОЙКА	21
FAIRINGS / ОБТЕКАТЕЛИ	22
MUD-SCREENS / ЩИТКИ.....	23
WHEELS / КОЛЕСА	25
BRAKES / ТОРМОЗА	27
03. ENGINE AND ITS SYSTEMS / ДВИГАТЕЛЬ И ЕГО СИСТЕМЫ	29
ENGINE MOUNT / МОТОРАМА.....	29
CONTROL SYSTEM / СИСТЕМА УПРАВЛЕНИЯ	30
FUEL SYSTEM / ТОПЛИВНАЯ СИСТЕМА	35
OIL SYSTEM / МАСЛОСИСТЕМА	36
COOLING SYSTEM / СИСТЕМА ОХЛАЖДЕНИЯ.....	37
EXHAUST SYSTEM / ВЫХЛОПНАЯ СИСТЕМА	38
04. PROPELLER / ВОЗДУШНЫЙ ВИНТ.....	42
SPINNER / КОК.....	42
PROPELLER / ВИНТ	43
05. AIRPLANE CONTROL SYSTEM / СИСТЕМА УПРАВЛЕНИЯ САМОЛЕТОМ....	44
CONTROL SYSTEM LEVERS / ПОСТЫ СИСТЕМЫ УПРАВЛЕНИЯ.....	44
AILERON CONTROL SYSTEM / СИСТЕМА УПРАВЛЕНИЯ ЭЛЕРОНАМИ	50
ELEVATOR CONTROL SYSTEM / СИСТЕМА УПРАВЛЕНИЯ РУ	52
RUDDER CONTROL SYSTEM / СИСТЕМА УПРАВЛЕНИЯ РН.....	54
AUTOPILOT / АВТОПИЛОТ	55
06. ELECTRICAL SYSTEM / ЭЛЕКТРОСИСТЕМА.....	56
ELECTRICAL EQUIPMENT / ЭЛЕКТРООБОРУДОВАНИЕ.....	56
INSTRUMENTS / ПРИБОРНОЕ ОБОРУДОВАНИЕ	58
07. SOCRIT EQUIPMENT / ОБОРУДОВАНИЕ КАБИНЫ.....	60
SEATS / СИДЕНЬЯ	60
HARNES BELTS / ПРИВЯЗНАЯ СИСТЕМА	62
08. CONSUMABLE MATERIALS / РАСХОДНЫЕ МАТЕРИАЛЫ	63
CATALOG STRUCTURE / СТРУКТУРА КАТАЛОГА.....	65

INTRODUCTION / ВВЕДЕНИЕ

Significance of the catalog number (PART NO.) symbols:

Значение цифр каталожного номера (НОМЕР):

A32x-AB-CDEF G

- A32x** - airplane type / тип самолета: **A32/A32L**;
- AB** - catalog chapter number / номер раздела каталога;
- CDEF** - item number within catalog chapter / номер позиции в разделе каталога
- G** - version: «R» - right-hand, «L» - left-hand, or omitted if not “handed” /
исполнение: «R» - правое, «L» - левое, либо отсутствует.

01. AIRFRAME / ПЛАНЕР

Fuselage / Фюзеляж





	<p>NAME: Fuselage with fin, not painted, assembled by agreement (A32 only) PART NO.: A32-01-0001 WEIGHT: 47.4 kg</p>
	<p>NAME: Fuselage with fin, not painted, assembled by agreement (A32L only) PART NO.: A32L-01-0001 WEIGHT: 44.67 kg</p>
	<p>NAME: Tail boom assembly, not painted PART NO.: A32-01-0002 WEIGHT: 10.74 kg</p>
	<p>NAME: Top cowling, not painted PART NO.: A32-01-0003 WEIGHT: 1.435 kg</p>

	<p>NAME: Top cowling, painted PART NO.: A32-01-0004 WEIGHT: 1.585 kg</p>
	<p>НАИМЕН.: Верхняя часть капота, окрашенная НОМЕР: A32-01-0004 ВЕС: 1.585 кг</p>
	<p>NAME: Bottom cowling, not painted PART NO.: A32-01-0005 WEIGHT: 1.728 kg</p>
	<p>НАИМЕН.: Нижняя часть капота, неокрашенная НОМЕР: A32-01-0005 ВЕС: 1.728 кг</p>
	<p>NAME: Bottom cowling, painted PART NO.: A32-01-0006 WEIGHT: 1.89 kg</p>
	<p>НАИМЕН.: Нижняя часть капота, окрашенная НОМЕР: A32-01-0006 ВЕС: 1.89 кг</p>
	<p>NAME: Cowling lock pin set PART NO.: A32-01-0014 WEIGHT: 0.029 kg</p>
	<p>НАИМЕН.: Комплект штифтов замков капота НОМЕР: A32-01-0014 ВЕС: 0.029 кг</p>

	<p>NAME: Cowling lock socket set PART NO.: A32-01-0015 WEIGHT: 0.045 kg</p>
	<p>НАИМЕН.: Комплект гнезд замков капота НОМЕР: A32-01-0015 ВЕС: 0.045 кг</p>
	<p>NAME: Firewall assembly, not painted PART NO.: A32-01-0007 WEIGHT: 4.04 kg</p>
	<p>НАИМЕН.: Первый шпангоут в сборе, неокрашенный НОМЕР: A32-01-0007 ВЕС: 4.04 кг</p>
	<p>NAME: Floor panel, forward, not painted PART NO.: A32-01-0008 WEIGHT: 1.918 kg</p>
	<p>НАИМЕН.: Панель пола, передняя, неокрашенная НОМЕР: A32-01-0008 ВЕС: 1.918 кг</p>
	<p>NAME: Frame No. 10 PART NO.: A32-01-0009 WEIGHT: 0.262 kg</p>
	<p>НАИМЕН.: Шпангоут №10 НОМЕР: A32-01-0009 ВЕС: 0.262 кг</p>



	<p>NAME: Stabilator hinge brackets (a set) PART NO.: A32-01-0011 WEIGHT: 0.158 kg</p>
	<p>НАИМЕН.: Кронштейны навески ЦПГО (комплект) НОМЕР: A32-01-0011 ВЕС: 0.158 кг</p>
	<p>NAME: Tail skid PART NO.: A32-01-0010 WEIGHT: 0.21 kg</p>
	<p>НАИМЕН.: Хвостовая рессора НОМЕР: A32-01-0010 ВЕС: 0.21 кг</p>
	<p>NAME: Tail fairing, not painted PART NO.: A32-01-0012 WEIGHT: 0.38 kg</p>
	<p>НАИМЕН.: Стекатель, неокрашенный НОМЕР: A32-01-0012 ВЕС: 0.38 кг</p>
	<p>NAME: Tail fairing, painted PART NO.: A32-01-0013 WEIGHT: 0.415 kg</p>
	<p>НАИМЕН.: Стекатель, окрашенный НОМЕР: A32-01-0013 ВЕС: 0.415 кг</p>

Wing / Крыло

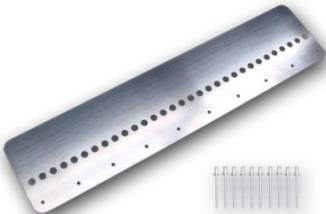
	<p>NAME: Outer wing, not covered (A32 only) PART NO.: A32-01-1000 R A32-01-1000 L WEIGHT: 21.1 kg</p> <hr/> <p>НАИМЕН.: Консоль крыла, не обтянутая (только для А32) НОМЕР: A32-01-1000 R A32-01-1000 L ВЕС: 21.1 кг</p>
	<p>NAME: Outer wing, painted (A32 only) PART NO.: A32-01-1001 R A32-01-1001 L WEIGHT: 23.4 kg</p> <hr/> <p>НАИМЕН.: Консоль крыла, окрашенная (только для А32) НОМЕР: A32-01-1001 R A32-01-1001 L ВЕС: 23.4 кг</p>
	<p>NAME: Outer wing, not covered (A32L only) PART NO.: A32L-01-1000 R A32L-01-1000 L WEIGHT: 16.7 kg</p> <hr/> <p>НАИМЕН.: Консоль крыла, не обтянутая (только для А32L) НОМЕР: A32L-01-1000 R A32L-01-1000 L ВЕС: 16.7 кг</p>
	<p>NAME: Outer wing, painted (A32L only) PART NO.: A32L-01-1001 R A32L-01-1001 L WEIGHT: 18.8 kg</p> <hr/> <p>НАИМЕН.: Консоль крыла, окрашенная (только для А32L) НОМЕР: A32L-01-1001 R A32L-01-1001 L ВЕС: 18.8 кг</p>





	<p>NAME: Flaperon hinge bracket bearings (a set) PART NO.: A22LS-01-1002 WEIGHT: 0.021 kg</p>
	<p>НАИМЕН.: Втулки кронштейнов навески флаперона (комплект) НОМЕР: A22LS-01-1002 ВЕС: 0.021 кг</p>
	<p>NAME: Flaperon, not covered PART NO.: A32-01-1002 R A32-01-1002 L WEIGHT: 3.3 kg</p>
	<p>НАИМЕН.: Флаперон, не обтянутый НОМЕР: A32-01-1002 R A32-01-1002 L ВЕС: 3.3 кг</p>
	<p>NAME: Flaperon, painted PART NO.: A32-01-1003 R A32-01-1003 L WEIGHT: 4.3 kg</p>
	<p>НАИМЕН.: Флаперон, окрашенный НОМЕР: A32-01-1003 R A32-01-1003 L ВЕС: 4.3 кг</p>
	<p>NAME: Flaperon trim tab, not painted PART NO.: A22LS-01-1005 WEIGHT: 0.025 kg</p>
	<p>НАИМЕН.: Триммер флаперона, неокрашенный НОМЕР: A22LS-01-1005 ВЕС: 0.025 кг</p>

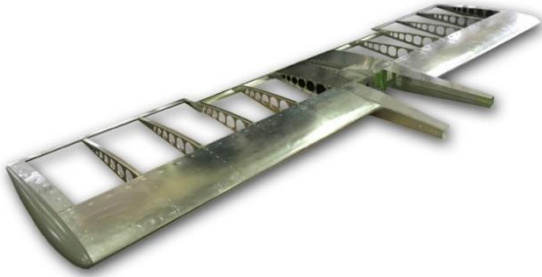

	<p>NAME: Flaperon trim tab, painted PART NO.: A22LS-01-1006 WEIGHT: 0.03 kg</p>
	<p>НАИМЕН.: Триммер флаперона, окрашенный НОМЕР: A22LS-01-1006 ВЕС: 0.03 кг</p>
	<p>NAME: Fuel tank 45 L, not painted PART NO.: A22LS-01-1007 R A22LS-01-1007 L WEIGHT: 3.19 kg</p>
	<p>НАИМЕН.: Бак топливный 45 л, неокрашенный НОМЕР: A22LS-01-1007 R A22LS-01-1007 L ВЕС: 3.19 кг</p>
	<p>NAME: Fuel tank cap PART NO.: A22LS-01-1008 WEIGHT: 0.075 kg</p>
	<p>НАИМЕН.: Крышка топливного бака НОМЕР: A22LS-01-1008 ВЕС: 0.075 кг</p>
	<p>NAME: Wing strut, painted PART NO.: A32-01-1004 R A32-01-1004 L WEIGHT: 3.6 kg</p>
	<p>НАИМЕН.: Подкос крыла, окрашенный НОМЕР: A32-01-1004 R A32-01-1004 L ВЕС: 3.6 кг</p>

	<p>NAME: Wing strut fairings, painted (a set) PART NO.: A32-01-1005 WEIGHT: 0.96 kg</p>
	<p>NAME: Pitot tube PART NO.: A32-01-1006 WEIGHT: 0.3 kg</p>
	<p>NAME: Pitot tube with angle attack sensor PART NO.: A32-01-1007 WEIGHT: 0.32 kg</p>
	<p>NAME: Wing covering, DIATEX fabric PART NO.: A22LS-01-1013 WEIGHT: 0.18 kg</p>
	<p>НАИМЕН.: Обтекатели подкосов, окрашенные (комплект) НОМЕР: A32-01-1005 ВЕС: 0.96 кг</p> <p>НАИМЕН.: Приемник воздушного давления НОМЕР: A32-01-1006 ВЕС: 0.3 кг</p> <p>НАИМЕН.: Приемник воздушного давления с датчиком угла атаки НОМЕР: A32-01-1007 ВЕС: 0.32 кг</p> <p>NAME: Wing covering, DIATEX fabric PART NO.: A22LS-01-1013 WEIGHT: 0.18 kg</p> <p>НАИМЕН.: Обшивка крыла (ткань DIATEX) НОМЕР: A22LS-01-1013 ВЕС: 0.18 кг</p>





	<p>NAME: Wing covering, upper, DIATEX fabric, (A32L only) PART NO.: A22L2-01-1002 WEIGHT: 0.22 kg</p>
	<p>NAME: Flaperon covering, DIATEX fabric PART NO.: A22LS-01-1014 WEIGHT: 0.27 kg</p>
	<p>NAME: Tie-down rings PART NO.: A22LS-01-1015 WEIGHT: 0.1 kg</p>
	<p>NAME: Set of fasteners for installation of outer wings and wing struts PART NO.: A32-01-1008 WEIGHT: 0.222 kg</p>
	<p>НАИМЕН.: Швартовочные проушины НОМЕР: A22LS-01-1015 ВЕС: 0.1 кг</p>
	<p>НАИМЕН.: Комплект крепежа для установки консолей крыла и подкосов НОМЕР: A32-01-1008 ВЕС: 0.222 кг</p>

Horizontal empennage / Горизонтальное оперение

	<p>NAME: Stabilator, not covered PART NO.: A32-01-2000 WEIGHT: 6.9 kg</p> <hr/> <p>НАИМЕН.: Цельноповоротное горизонтальное оперение (ЦПГО), не обтянутое НОМЕР: A32-01-2000 ВЕС: 6.9 кг</p>
	<p>NAME: Stabilator, painted PART NO.: A32-01-2001 WEIGHT: 8.1 kg</p> <hr/> <p>НАИМЕН.: Цельноповоротное горизонтальное оперение (ЦПГО), окрашенное НОМЕР: A32-01-2001 ВЕС: 8.1 кг</p>
	<p>NAME: Stabilator trim tab, not painted PART NO.: A32-01-2002 WEIGHT: 0.35 kg</p> <hr/> <p>НАИМЕН.: Триммер ЦПГО, неокрашенный НОМЕР: A32-01-2002 ВЕС: 0.35 кг</p>
	<p>NAME: Stabilator trim tab, painted PART NO.: A32-01-2003 WEIGHT: 0.4 kg</p> <hr/> <p>НАИМЕН.: Триммер ЦПГО, окрашенный НОМЕР: A32-01-2003 ВЕС: 0.4 кг</p>

	<p>NAME: Stabilator covering (DIATEX fabric) PART NO.: A32-01-2004 WEIGHT: 0.6 kg</p>
	<p>НАИМЕН.: Обшивка ЦПГО (ткань DIATEX) НОМЕР: A32-01-2004 ВЕС: 0.6 кг</p>
	<p>NAME: Stabilator fasteners PART NO.: A32-01-2005 WEIGHT: 0.05 kg</p>
	<p>НАИМЕН.: Крепеж навески ЦПГО НОМЕР: A32-01-2005 ВЕС: 0.05 кг</p>





Vertical empennage / Вертикальное оперение

	<p>NAME: Set of fin parts, not painted PART NO.: A32-01-3000 WEIGHT: 2.8 kg</p>
	<p>НАИМЕН.: Набор деталей киля, неокрашенный НОМЕР: A32-01-3000 ВЕС: 2.8 кг</p>
	<p>NAME: Rudder, not covered PART NO.: A32-01-3001 WEIGHT: 1.1 kg</p>
	<p>НАИМЕН.: Руль направления, не обтянутый НОМЕР: A32-01-3001 ВЕС: 1.1 кг</p>
	<p>NAME: Rudder, painted PART NO.: A32-01-3002 WEIGHT: 1.4 kg</p>
	<p>НАИМЕН.: Руль направления, окрашенный НОМЕР: A32-01-3002 ВЕС: 1.4 кг</p>
	<p>NAME: Rudder covering (DIATEX fabric) PART NO.: A22LS-01-3003 WEIGHT: 0.13 kg</p>
	<p>НАИМЕН.: Обшивка руля направления (ткань DIATEX) НОМЕР: A22LS-01-3003 ВЕС: 0.13 кг</p>

Glass / Остекление





	NAME: Acrylic windscreen glass PART NO.: A32-01-4000 WEIGHT: 3.8 kg
	НАИМЕН.: Акриловое лобовое стекло НОМЕР: A32-01-4000 ВЕС: 3.8 кг
	NAME: Windscreen glass edging, painted PART NO.: A32-01-4001 WEIGHT: 0.29 kg
	НАИМЕН.: Панки лобового стекла, окрашенные НОМЕР: A32-01-4001 ВЕС: 0.29 кг

Doors / Двери

	<p>NAME: Door, painted PART NO.: A32-01-5000 R A32-01-5000 L WEIGHT: 3.7 kg</p>
	<p>НАИМЕН.: Дверь, окрашенная НОМЕР: A32-01-5000 R A32-01-5000 L ВЕС: 3.7 кг</p>
	<p>NAME: Door glass PART NO.: A32-01-5001 R A32-01-5001 L WEIGHT: 1.8 kg</p>
	<p>НАИМЕН.: Стекло двери НОМЕР: A32-01-5001 R A32-01-5001 L ВЕС: 1.8 кг</p>
	<p>NAME: Vent scoop PART NO.: A22LS-01-5003 WEIGHT: 0.02 kg</p>
	<p>НАИМЕН.: Форточка НОМЕР: A22LS-01-5003 ВЕС: 0.02 кг</p>
	<p>NAME: Gas strut PART NO.: A22LS-01-5004 WEIGHT: 0.25 kg</p>
	<p>НАИМЕН.: Газовая пружина НОМЕР: A22LS-01-5004 ВЕС: 0.25 кг</p>

02. LANDING GEAR / ШАССИ

Nose leg / Передняя стойка

	<p>NAME: Nose landing gear leg 6x6, primed PART NO.: A32-02-0004 WEIGHT: 4.952 kg</p>
	<p>НАИМЕН.: Передняя стойка шасси 6x6, грунтованная НОМЕР: A32-02-0004 ВЕС: 4.952 кг</p>
	<p>NAME: Nose landing gear leg 6x6, painted PART NO.: A32-02-0001 WEIGHT: 4.967 kg</p>
	<p>НАИМЕН.: Передняя стойка шасси 6x6, окрашенная НОМЕР: A32-02-0001 ВЕС: 4.967 кг</p>
	<p>NAME: Nose landing gear leg 8x6, primed PART NO.: A32-02-0005 WEIGHT: 5.904 kg</p>
	<p>НАИМЕН.: Передняя стойка шасси 8x6, грунтованная НОМЕР: A32-02-0005 ВЕС: 5.904 кг</p>
	<p>NAME: Nose landing gear leg 8x6, painted PART NO.: A32-02-0006 WEIGHT: 5.919 kg</p>
	<p>НАИМЕН.: Передняя стойка шасси 8x6, окрашенная НОМЕР: A32-02-0006 ВЕС: 5.919 кг</p>



	<p>NAME: Nose wheel fork 6x6 PART NO.: A22LS-02-0002 WEIGHT: 2.304 kg</p>
	<p>НАИМЕН.: Вилка передней стойки 6x6 НОМЕР: A22LS-02-0002 ВЕС: 2.304 кг</p>
	<p>NAME: Nose wheel fork 8x6 PART NO.: A22LS-02-0013 WEIGHT: 3.179 kg</p>
	<p>НАИМЕН.: Вилка передней стойки 8x6 НОМЕР: A22LS-02-0013 ВЕС: 3.179 кг</p>
	<p>NAME: 6x6 Nose landing gear strut with bellcrank, primed PART NO A32-02-0007 WEIGHT: 2.109 kg</p>
	<p>НАИМЕН.: Рычаг передней стойки 6x6 с качалкой, грунтованный НОМЕР: A32-02-0007 ВЕС: 2.109 кг</p>
	<p>NAME: 6x6 Nose landing gear strut with bellcrank, painted PART NO A32-02-0002 WEIGHT: 2.124 kg</p>
	<p>НАИМЕН.: Рычаг передней стойки 6x6 с качалкой, окрашенный НОМЕР: A32-02-0002 ВЕС: 2.124 кг</p>

	<p>NAME: 8x6 Nose landing gear strut with bellcrank, primed PART NO A32-02-0008 WEIGHT: 2.071 kg</p>
	<p>НАИМЕН.: Рычаг передней стойки 8x6 с качалкой, грунтованный НОМЕР: A32-02-0008 ВЕС: 2.071 кг</p>
	<p>NAME: 8x6 Nose landing gear strut with bellcrank, painted PART NO A32-02-0009 WEIGHT: 2.086 kg</p>
	<p>НАИМЕН.: Рычаг передней стойки 8x6 с качалкой, окрашенный НОМЕР: A32-02-0009 ВЕС: 2.086 кг</p>
	<p>NAME: Spring shock absorber PART NO.: A22LS-02-0004 WEIGHT: 0.39 kg</p>
	<p>НАИМЕН.: Пружинный амортизатор НОМЕР: A22LS-02-0004 ВЕС: 0.39 кг</p>
	<p>NAME: Nose landing gear strut support assembly, not painted PART NO.: A32-02-0003 WEIGHT: 0.8 kg</p>
	<p>НАИМЕН.: Опора передней стойки в сборе, неокрашенная НОМЕР: A32-02-0003 ВЕС: 0.8 кг</p>

Main leg / Основная стойка

	<p>NAME: Main landing gear leg with 6x6(8x6) wheel axle, not painted PART NO.: A22LS-02-1001 WEIGHT: 3.851 kg</p>
	<p>НАИМЕН.: Основная стойка с осью 6x6(8x6), неокрашенная НОМЕР: A22LS-02-1001 ВЕС: 3.851 кг</p>
	<p>NAME: Main landing gear leg with 6x6(8x6) wheel axle, painted PART NO.: A22LS-02-1000 WEIGHT: 3.881 kg</p>
	<p>НАИМЕН.: Основная стойка в сборе 6x6(8x6), окрашенная НОМЕР: A22LS-02-1000 ВЕС: 3.881 кг</p>
	<p>NAME: Fasteners for installation of A32 main landing gear PART NO.: A32-02-1000 WEIGHT: 0.153 kg</p>
	<p>НАИМЕН.: Крепеж для установки основной стойки А32 НОМЕР: A32-02-1000 ВЕС: 0.153 кг</p>

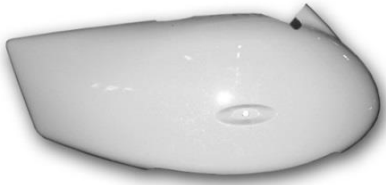
Fairings / Обтекатели

	<p>NAME: Nose wheel fairing, not painted PART NO.: A32-02-2000 WEIGHT: 0.75 kg</p> <hr/> <p>НАИМЕН.: Обтекатель носового колеса, неокрашенный НОМЕР: A32-02-2000 ВЕС: 0.75 кг</p>
	<p>NAME: Nose wheel fairing, painted PART NO.: A32-02-2001 WEIGHT: 0.8 kg</p> <hr/> <p>НАИМЕН.: Обтекатель носового колеса, окрашенный НОМЕР: A32-02-2001 ВЕС: 0.8 кг</p>
	<p>NAME: Main wheel fairing, not painted PART NO.: A22LS-02-2002 R A22LS-02-2002 L WEIGHT: 0.65 kg</p> <hr/> <p>НАИМЕН.: Обтекатель основного колеса, неокрашенный НОМЕР: A22LS-02-2002 R A22LS-02-2002 L ВЕС: 0.65 кг</p>
	<p>NAME: Main wheel fairing, painted PART NO.: A22LS-02-2003 R A22LS-02-2003 L WEIGHT: 0.7 kg</p> <hr/> <p>НАИМЕН.: Обтекатель основного колеса, окрашенный НОМЕР: A22LS-02-2003 R A22LS-02-2003 L ВЕС: 0.7 кг</p>

Mud-screens / Щитки

	<p>NAME: Cheng shin 6x6 nose wheel mud-screen PART NO A22LS-02-3000 WEIGHT: 0.276 kg</p> <hr/> <p>НАИМЕН.: Щиток носового колеса 6x6 Cheng shin НОМЕР: A22LS-02-3000 ВЕС: 0.276 кг</p>
	<p>NAME: Airtrac 6x6 nose wheel mud-screen PART NO A22LS-02-3002 WEIGHT: 0.266 kg</p> <hr/> <p>НАИМЕН.: Щиток носового колеса 6x6 Airtrac НОМЕР: A22LS-02-3002 ВЕС: 0.266 кг</p>
	<p>NAME: Carlisle-Tyre 8x6 nose wheel mud-screen PART NO A22LS-02-3003 WEIGHT: 0.382 kg</p> <hr/> <p>НАИМЕН.: Щиток носового колеса 8x6 Carlisle-Tyre НОМЕР: A22LS-02-3003 ВЕС: 0.382 кг</p>
	<p>NAME: Cheng shin 6x6 main wheel mud-screen PART NO.: A22LS-02-3001 R A22LS-02-3001 L WEIGHT: 0.433 kg</p> <hr/> <p>НАИМЕН.: Щиток основного колеса 6x6 Cheng shin НОМЕР: A22LS-02-3001 R A22LS-02-3001 L ВЕС: 0.433 кг</p>

 The image shows the Airtrac 6x6 main wheel mud-screen assembly. It consists of a curved metal mounting bracket on the left, a semi-circular mud-screen plate on the right, and a set of six screws with washers in the center.	<p>NAME: Airtrac 6x6 main wheel mud-screen PART NO.: A22LS-02-3004 R A22LS-02-3004 L WEIGHT: 0.433 kg</p> <hr/> <p>НАИМЕН.: Щиток основного колеса 6x6 Airtrac НОМЕР: A22LS-02-3004 R A22LS-02-3004 L ВЕС: 0.433 кг</p>
 The image shows the Carlisle-Tyre 8x6 main wheel mud-screen assembly. It consists of a curved metal mounting bracket on the left, a semi-circular mud-screen plate on the right, and a set of six screws with washers in the center.	<p>NAME: Carlisle-Tyre 8x6 main wheel mud-screen PART NO.: A22LS-02-3005 R A22LS-02-3005 L WEIGHT: 0.548 kg</p> <hr/> <p>НАИМЕН.: Щиток основного колеса 8x6 Carlisle-Tyre НОМЕР: A22LS-02-3005 R A22LS-02-3005 L ВЕС: 0.548 кг</p>

Wheels / Колеса

	<p>NAME: Cheng shin 6x6 tyre and tube PART NO.: A22LS-02-4001 WEIGHT: 2.662 kg</p>
	<p>НАИМЕН.: Шина Cheng shin 6x6 и камера НОМЕР: A22LS-02-4001 ВЕС: 2.662 кг</p>
	<p>NAME: AirTrac 6x6 tyre and tube PART NO.: A22LS-02-4002 WEIGHT: 3.138 kg</p>
	<p>НАИМЕН.: Шина AirTrac 6x6 и камера НОМЕР: A22LS-02-4002 ВЕС: 3.138 кг</p>
	<p>NAME: Carlisle-Tyre 8x6 tyre and tube PART NO.: A22LS-02-4003 WEIGHT: 4.223 kg</p>
	<p>НАИМЕН.: Шина Carlisle-Tyre 8x6 и камера НОМЕР: A22LS-02-4003 ВЕС: 4.223 кг</p>
	<p>NAME: Nose wheel PART NO.: A22LS-02-4004 WEIGHT: 1.2 kg</p>
	<p>НАИМЕН.: Носовое колесо НОМЕР: A22LS-02-4004 ВЕС: 1.2 кг</p>



	<p>NAME: Wheel with brake PART NO.: A22LS-02-4005 WEIGHT: 1.621 kg</p>
	<p>НАИМЕН.: Тормозное колесо НОМЕР: A22LS-02-4005 ВЕС: 1.621 кг</p>
	<p>NAME: Brake disk PART NO.: A22LS-02-4006 WEIGHT: 0.393 kg</p>
	<p>НАИМЕН.: Тормозной диск НОМЕР: A22LS-02-4006 ВЕС: 0.393 кг</p>

Brakes / Тормоза

 <p>The image shows a yellow master brake cylinder with a silver piston rod. A label on the cylinder reads: 'MATCO inc. PART # MC-4A (8011 535-0502) 2981 SOUTH 1560 WEST WOODS CROSS, UT 84087'. Below the cylinder are two fittings: a brass 90-degree elbow and a black plastic 90-degree elbow.</p>	<p>NAME: Master brake cylinder (yoke) PART NO.: A22LS-02-5000 WEIGHT: 0.2 kg</p> <hr/> <p>НАИМЕН.: Главный тормозной цилиндр (штурвал) НОМЕР: A22LS-02-5000 ВЕС: 0.2 кг</p>
 <p>The image shows a yellow master brake cylinder with a silver piston rod, similar to the yoke version. A label on the cylinder reads: 'MATCO inc. PART # MC-4A (8011 535-0502) 2981 SOUTH 1560 WEST WOODS CROSS, UT 84087'. Below the cylinder are two fittings: a brass 90-degree elbow and a black plastic 90-degree elbow.</p>	<p>NAME: Master brake cylinder (stick) PART NO.: A22LS-02-5004 WEIGHT: 0.2 kg</p> <hr/> <p>НАИМЕН.: Главный тормозной цилиндр (ручка) НОМЕР: A22LS-02-5004 ВЕС: 0.2 кг</p>
 <p>The image shows a set of five brass fittings: three 90-degree elbows, one T-fitting, and one straight fitting. A black plastic 90-degree elbow is also shown.</p>	<p>NAME: Brake system fittings (yoke, a set) PART NO.: A32-02-5000 WEIGHT: 0.124 kg</p> <hr/> <p>НАИМЕН.: Фитинги тормозной системы (штурвал, комплект) НОМЕР: A32-02-5000 ВЕС: 0.124 кг</p>
 <p>The image shows a set of five brass fittings: three 90-degree elbows, one T-fitting, and one straight fitting. A black plastic 90-degree elbow is also shown.</p>	<p>NAME: Brake system fittings (stick, a set) PART NO.: A22LS-02-5001 WEIGHT: 0.132 kg</p> <hr/> <p>НАИМЕН.: Фитинги тормозной системы (ручка, комплект) НОМЕР: A22LS-02-5001 ВЕС: 0.132 кг</p>

	<p>NAME: Braking system tubing (a set) PART NO.: A22LS-02-5002 WEIGHT: 0.25 kg</p>
	<p>НАИМЕН.: Трубка тормозной системы (комплект) НОМЕР: A22LS-02-5002 ВЕС: 0.25 кг</p>
	<p>NAME: Braking system expansion tank PART NO.: A22LS-02-5003 WEIGHT: 0.04 kg</p>
	<p>НАИМЕН.: Тормозной расширительный бачок НОМЕР: A22LS-02-5003 ВЕС: 0.04 кг</p>
	<p>NAME: SwiftLine Kit for WHLB3 Brakes PART NO.: A22LS-02-5006 WEIGHT: 0.382 kg</p>
	<p>НАИМЕН.: Комплект тормозных колодок в сборе WHLB3 НОМЕР: A22LS-02-5006 ВЕС: 0.382 кг</p>

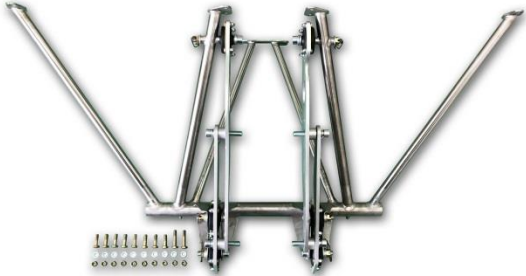
03. **ENGINE AND ITS SYSTEMS / ДВИГАТЕЛЬ И ЕГО СИСТЕМЫ****Engine mount / Моторама**

	<p>NAME: Engine mount (a set) PART NO.: A32-03-0001 WEIGHT: 7.42 kg</p>
	<p>NAME: Rubber shock absorbers (aircraft kit). Valid up to A32 s/n 119, A32L s/n 025 inclusive PART NO.: A22LS-03-0002 WEIGHT: 0.468 kg</p>
	<p>NAME: Rubber shock absorbers with rivets (aircraft kit). Valid from A32 s/n 120, A32L s/n 026 inclusive PART NO.: A32-03-0002 WEIGHT: 0.566 kg</p> <p>НАИМЕН.: Резиновые амортизаторы на заклепках (комплект на самолет). Действует с A32 s/n 120, A32L s/n 026 включительно НОМЕР: A32-03-0002 ВЕС: 0.566 кг</p>

Control system / Система управления

	<p>NAME: Carburettor heating (a set) PART NO.: A32-03-1000 WEIGHT: 0.5 kg</p> <hr/> <p>НАИМЕН.: Обогрев карбюраторов (комплект) НОМЕР: A32-03-1000 ВЕС: 0.5 кг</p>
	<p>NAME: Sealing ring PART NO.: A22LS-03-1001 WEIGHT: 0.005 kg</p> <hr/> <p>НАИМЕН.: Уплотнительное кольцо НОМЕР: A22LS-03-1001 ВЕС: 0.005 кг</p>
	<p>NAME: US/ULS/iS Bowden cable housing (right/left, stick) PART NO.: A32-03-1001 WEIGHT: 0.033 kg</p> <hr/> <p>НАИМЕН.: Боуден РУДа US(ULS)iS (прав/лв ручка) НОМЕР: A32-03-1001 ВЕС: 0.033 кг</p>
	<p>NAME: US/ULS throttle lever Bowden cable housing, right (yoke) PART NO.: A32-03-1002 WEIGHT: 0.077 kg</p> <hr/> <p>НАИМЕН.: Боуден РУДа US(ULS) правый (штурвал) НОМЕР: A32-03-1002 ВЕС: 0.077 кг</p>

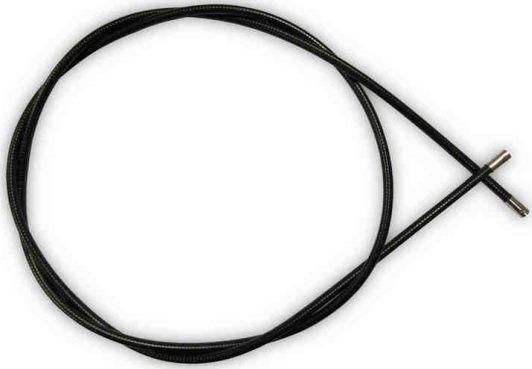
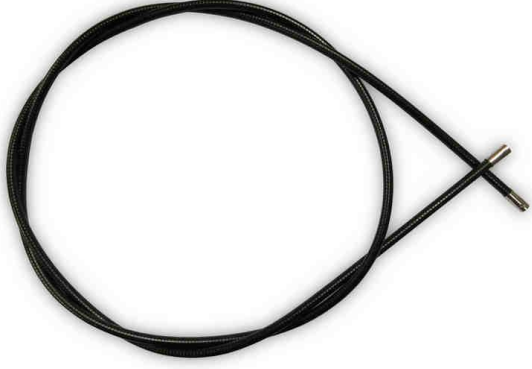
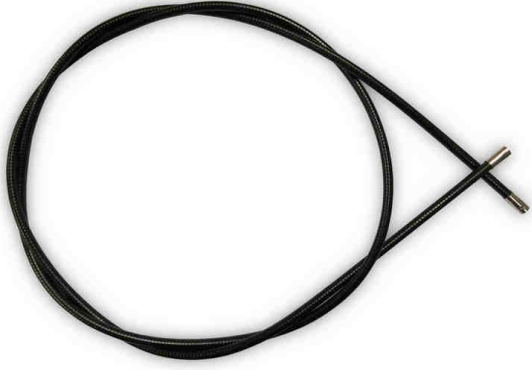
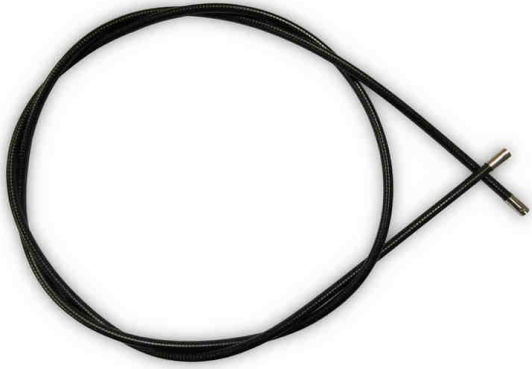
	<p>NAME: US/ULS throttle lever Bowden cable housing, left (yoke) PART NO.: A32-03-1003 WEIGHT: 0.076 kg</p>
	<p>NAME: iS throttle lever Bowden cable housing (yoke) PART NO.: A32-03-1004 WEIGHT: 0.084 kg</p>
	<p>NAME: Choke Bowden cable housing (right/left, stick) PART NO.: A32-03-1005 WEIGHT: 0.073 kg</p>
	<p>NAME: Choke Bowden cable housing, right (yoke) PART NO.: A32-03-1006 WEIGHT: 0.079 kg</p>
	<p>НАИМЕН.: Боуден РУДа US(ULS) левый (штурвал) НОМЕР: A32-03-1003 ВЕС: 0.076 кг</p> <p>НАИМЕН.: Боуден РУДа iS (штурвал) НОМЕР: A32-03-1004 ВЕС: 0.084 кг</p> <p>НАИМЕН.: Боуден обогатителя (пр/лв ручка) НОМЕР: A32-03-1005 ВЕС: 0.073 кг</p> <p>НАИМЕН.: Боуден обогатителя правый (штурвал) НОМЕР: A32-03-1006 ВЕС: 0.079 кг</p>

	<p>NAME: Choke Bowden cable housing, left (yoke) PART NO.: A32-03-1007 WEIGHT: 0.074 kg</p>
	<p>НАИМЕН.: Боден обогатителя левый (штурвал) НОМЕР: A32-03-1007 ВЕС: 0.074 кг</p>
	<p>NAME: US/ULS Bowden cable inner wire (right/left, stick) PART NO.: A32-03-1008 WEIGHT: 0.009 kg</p>
	<p>НАИМЕН.: Трос РУДа US(ULS) (прав/лв ручка) НОМЕР: A32-03-1008 ВЕС: 0.009 кг</p>
	<p>NAME: iS throttle lever Bowden cable inner wire (stick) PART NO.: A32-03-1009 WEIGHT: 0.009 kg</p>
	<p>НАИМЕН.: Трос РУДа iS (ручка) НОМЕР: A32-03-1009 ВЕС: 0.009 кг</p>
	<p>NAME: US/ULS throttle lever Bowden cable inner wire, right (yoke) PART NO.: A32-03-1010 WEIGHT: 0.020 kg</p>
	<p>НАИМЕН.: Трос РУДа US(ULS) правый (штурвал) НОМЕР: A32-03-1010 ВЕС: 0.020 кг</p>

	<p>NAME: US/ULS throttle lever Bowden cable inner wire, left (yoke) PART NO.: A32-03-1011 WEIGHT: 0.019 kg</p>
	<p>НАИМЕН.: Трос РУДа US(ULS) левый (штурвал) НОМЕР: A32-03-1011 ВЕС: 0.019 кг</p>
	<p>NAME: iS throttle lever Bowden cable inner wire (yoke) PART NO.: A32-03-1012 WEIGHT: 0.022 kg</p>
	<p>НАИМЕН.: Трос РУДа iS (штурвал) НОМЕР: A32-03-1012 ВЕС: 0.022 кг</p>
	<p>NAME: Choke Bowden cable inner wire (right/left, stick) PART NO.: A32-03-1013 WEIGHT: 0.017 kg</p>
	<p>НАИМЕН.: Трос обогатителя (прав/лев ручка) НОМЕР: A32-03-1013 ВЕС: 0.017 кг</p>
	<p>NAME: Choke Bowden cable inner wire, right (yoke) PART NO.: A32-03-1014 WEIGHT: 0.018 kg</p>
	<p>НАИМЕН.: Трос обогатителя правый (штурвал) НОМЕР: A32-03-1014 ВЕС: 0.018 кг</p>

	<p>NAME: Choke Bowden cable inner wire, left (yoke) PART NO.: A32-03-1015 WEIGHT: 0.017 kg</p>
	<p>НАИМЕН.: Трос обогатителя левый (штурвал) НОМЕР: A32-03-1015 ВЕС: 0.017 кг</p>

Fuel system / Топливная система

	<p>NAME: Sediment container PART NO.: A32-03-2000 WEIGHT: 0.084 kg</p>
	<p>НАИМЕН.: Отстойник НОМЕР: A32-03-2000 ВЕС: 0.084 кг</p>
	<p>NAME: Fuel filter PART NO.: A22LS-03-2001 WEIGHT: 0.01 kg</p>
	<p>НАИМЕН.: Топливный фильтр НОМЕР: A22LS-03-2001 ВЕС: 0.01 кг</p>
 <p>IMAGE COMING SOON</p>	<p>NAME: 5-year rubber parts replacement kit. Without ROTAX parts. PART NO.: A32-03-2001 WEIGHT: 2.268 kg</p>
	<p>НАИМЕН.: Комплект для замены резиновых частей по 5-ти летнему сроку. Без частей ROTAX. НОМЕР: A32-03-2001 ВЕС: 2.268 кг</p>





Oil system / Маслосистема

	NAME: Hoses and fitting of oil system (set) PART NO.: A32-03-3001 WEIGHT: 0.602 kg
	НАИМЕН.: Шланги и фитинги маслосистемы (комплект) НОМЕР: A32-03-3001 ВЕС: 0.602 кг





Cooling system / Система охлаждения

	<p>NAME: Cooling system hoses (a set) PART NO.: A32-03-4000 WEIGHT: 0.899 kg</p> <hr/> <p>НАИМЕН.: Патрубки системы охлаждения (комплект) НОМЕР: A32-03-4000 ВЕС: 0.899 кг</p>
---	--

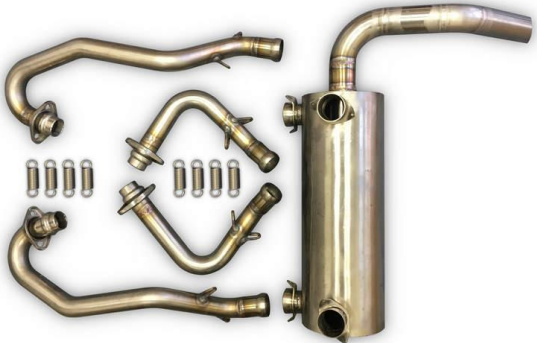
Exhaust system / Выхлопная система

	<p>NAME: Exhaust system with Rotax exhaust muffler (a set: pipes without holes, without threaded bushings for exhaust gas temperature sensors) PART NO.: A32-03-5000 WEIGHT: 4.295 kg</p> <p>НАИМЕН.: Выхлопная система с глушителем Rotax (комплект: патрубки без отв., без резьбовых втулок под датчики температуры выхлопных газов) НОМЕР: A32-03-5000 ВЕС: 4.295 кг</p>
	<p>NAME: Rotax exhaust muffler assembly PART NO.: A32-03-5001 WEIGHT: 2.57 kg</p> <p>НАИМЕН.: Глушитель Rotax в сборе НОМЕР: A32-03-5001 ВЕС: 2.57 кг</p>
	<p>NAME: Cyl. 1 exhaust pipe for Rotax exhaust muffler (without holes, without threaded bushings for exhaust gas temperature sensors) PART NO.: A32-03-5002 WEIGHT: 0.474 kg</p> <p>НАИМЕН.: Выхлопной патрубок для глушителя Rotax 1-го цил. (без отв., без резьбовых втулок под датчики температуры выхлопных газов) НОМЕР: A32-03-5002 ВЕС: 0.474 кг</p>
	<p>NAME: Cyl. 2 exhaust pipe for Rotax exhaust muffler (without holes, without threaded bushings for exhaust gas temperature sensors) PART NO.: A32-03-5003 WEIGHT: 0.461 kg</p> <p>НАИМЕН.: Выхлопной патрубок для глушителя Rotax 2-го цил. (без отв., без резьбовых втулок под датчики температуры выхлопных газов) НОМЕР: A32-03-5003 ВЕС: 0.461 кг</p>

	<p>NAME: Cyl. 3 exhaust pipe for Rotax exhaust muffler (without holes, without threaded bushings for exhaust gas temperature sensors) PART NO.: A32-03-5004 WEIGHT: 0.299 kg</p>
	<p>NAME: Cyl. 4 exhaust pipe for Rotax exhaust muffler (without holes, without threaded bushings for exhaust gas temperature sensors) PART NO.: A32-03-5005 WEIGHT: 0.323 kg</p>
	<p>NAME: Springs for the exhaust system with Rotax exhaust muffler (a set) PART NO.: A22LS-03-5006 WEIGHT: 0.168 kg</p>
	<p>NAME: Exhaust system with Aeroweld exhaust muffler (a set: pipes without holes, without threaded bushings for exhaust gas temperature sensors) PART NO.: A32-03-5006 WEIGHT: 3.897 kg</p>
	<p>НАИМЕН.: Выхлопной патрубок для глушителя Rotax 3-го цил. (без отв., без резьбовых втулок под датчики температуры выхлопных газов) НОМЕР: A32-03-5004 ВЕС: 0.299 кг</p>
	<p>НАИМЕН.: Выхлопной патрубок для глушителя Rotax 4-го цил. (без отв., без резьбовых втулок под датчики температуры выхлопных газов) НОМЕР: A32-03-5005 ВЕС: 0.323 кг</p>
	<p>НАИМЕН.: Пружины выхлопной системы с глушителем Rotax (комплект) НОМЕР: A22LS-03-5006 ВЕС: 0.168 кг</p>
	<p>НАИМЕН.: Выхлопная система с глушителем Aeroweld (комплект: патрубки без отв., без резьбовых втулок под датчики температуры выхлопных газов) НОМЕР: A32-03-5006 ВЕС: 3.897 кг</p>

	<p>NAME: Aeroweld exhaust muffler assembly PART NO.: A32-03-5007 WEIGHT: 2.078 kg</p>
	<p>НАИМЕН.: Глушитель Aeroweld в сборе НОМЕР: A32-03-5007 ВЕС: 2.078 кг</p>
	<p>NAME: Cyl. 1 exhaust pipe for Aeroweld exhaust muffler (without holes, without threaded bushings for exhaust gas temperature sensors) PART NO.: A32-03-5008 WEIGHT: 0.51 kg</p>
	<p>НАИМЕН.: Выхлопной патрубок для глушителя Aeroweld 1-го цил. (без отв., без резьбовых втулок под датчики температуры выхлопных газов) НОМЕР: A32-03-5008 ВЕС: 0.51 кг</p>
	<p>NAME: Cyl. 2 exhaust pipe for Aeroweld exhaust muffler (without holes, without threaded bushings for exhaust gas temperature sensors) PART NO.: A32-03-5009 WEIGHT: 0.494 kg</p>
	<p>НАИМЕН.: Выхлопной патрубок для глушителя Aeroweld 2-го цил. (без отв., без резьбовых втулок под датчики температуры выхлопных газов) НОМЕР: A32-03-5009 ВЕС: 0.494 кг</p>
	<p>NAME: Cyl. 3 exhaust pipe for Aeroweld exhaust muffler (without holes, without threaded bushings for exhaust gas temperature sensors) PART NO.: A32-03-5010 WEIGHT: 0.35 kg</p>
	<p>НАИМЕН.: Выхлопной патрубок для глушителя Aeroweld 3-го цил. (без отв., без резьбовых втулок под датчики температуры выхлопных газов) НОМЕР: A32-03-5010 ВЕС: 0.35 кг</p>

	<p>NAME: Cyl. 4 exhaust pipe for Aeroweld exhaust muffler (without holes, without threaded bushings for exhaust gas temperature sensors) PART NO.: A32-03-5011 WEIGHT: 0.329 kg</p>
	<p>НАИМЕН.: Выхлопной патрубок для глушителя Aeroweld 4-го цил. (без отв., без резьбовых втулок под датчики температуры выхлопных газов) НОМЕР: A32-03-5011 ВЕС: 0.329 кг</p>
	<p>NAME: Springs for the exhaust system with Aeroweld exhaust muffler (a set) PART NO.: A22LS-03-5014 WEIGHT: 0.136 kg</p>
	<p>НАИМЕН.: Пружины выхлопной системы с глушителем Aeroweld (комплект) НОМЕР: A22LS-03-5014 ВЕС: 0.136 кг</p>
	<p>NAME: EGT sensor fittings, M8x1 inner thread (a set) PART NO.: A22LS-03-5007 WEIGHT: 0.05 kg</p>
	<p>НАИМЕН.: Втулки под датчики EGT, внутренняя резьба M8x1 (комплект) НОМЕР: A22LS-03-5007 ВЕС: 0.05 кг</p>

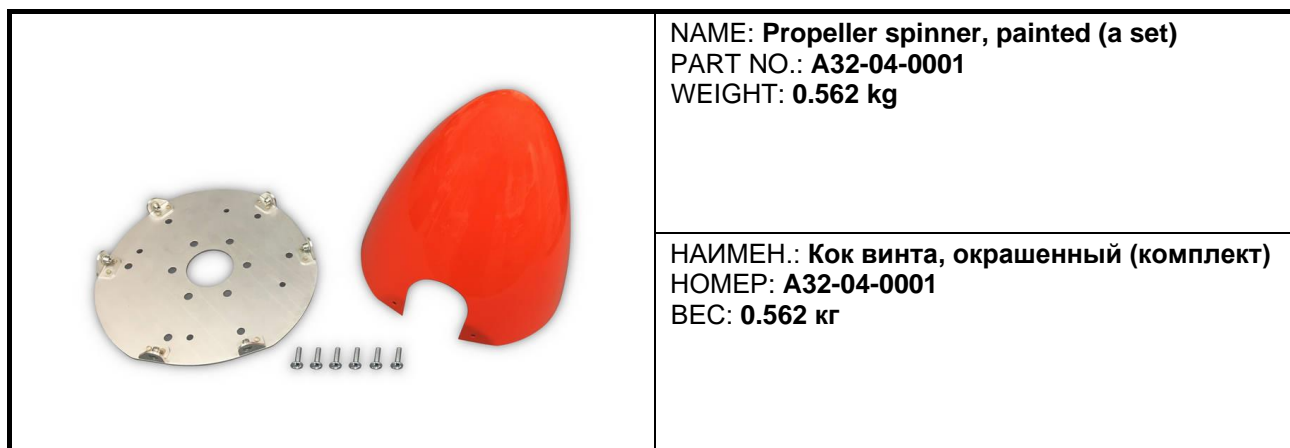

04. PROPELLER / ВОЗДУШНЫЙ ВИНТ**Spinner / Кок**

Propeller / Винт

	<p>NAME: KIEVPROP propeller 263/1700 (a set) PART NO.: A22LS-04-1000 WEIGHT: 4.068 kg</p>
	<p>НАИМЕН.: Воздушный винт КиевПроп 263/1700 (комплект) НОМЕР: A22LS-04-1000 ВЕС: 4.068 кг</p>
	<p>NAME: KIEVPROP propeller 283/1800 (a set) PART NO.: A22LS-04-1001 WEIGHT: 4.329 kg</p>
	<p>НАИМЕН.: Воздушный винт КиевПроп 283/1800 (комплект) НОМЕР: A22LS-04-1001 ВЕС: 4.329 кг</p>

05. AIRPLANE CONTROL SYSTEM / СИСТЕМА УПРАВЛЕНИЯ САМОЛЕТОМ

Control system levers / Посты системы управления

	<p>NAME: I-stick upper cover with fasteners PART NO.: A32-05-0003 WEIGHT: 0.1 kg</p>
	<p>НАИМЕН.: Чехол верхний для I-ручки с крепежом НОМЕР: A32-05-0003 ВЕС: 0.1 кг</p>
	<p>NAME: Y-stick upper cover with fasteners PART NO.: A32-05-0004 WEIGHT: 0.107 kg</p>
	<p>НАИМЕН.: Чехол верхний для Y-ручки с крепежом НОМЕР: A32-05-0004 ВЕС: 0.107 кг</p>
	<p>NAME: Lower cover PART NO.: A32-05-0005 WEIGHT: 0.037 kg</p>
	<p>НАИМЕН.: Чехол нижний НОМЕР: A32-05-0005 ВЕС: 0.037 кг</p>
	<p>NAME: Stick column stop PART NO.: A32-05-0006 WEIGHT: 0.411 kg</p>
	<p>НАИМЕН.: Фиксатор колонки ручки НОМЕР: A32-05-0006 ВЕС: 0.411 кг</p>

	<p>NAME: Yoke assembly with one button (right) PART NO.: A32-05-0007 WEIGHT: 1.051 kg</p>
	<p>НАИМЕН.: Штурвал в сборе с одной кнопкой (правый) НОМЕР: A32-05-0007 ВЕС: 1.051 кг</p>
	<p>NAME: Yoke assembly with one button (left) PART NO.: A32-05-0008 WEIGHT: 1.048 kg</p>
	<p>НАИМЕН.: Штурвал в сборе с одной кнопкой (левый) НОМЕР: A32-05-0008 ВЕС: 1.048 кг</p>
	<p>NAME: Yoke assembly with two buttons (right) PART NO.: A32-05-0009 WEIGHT: 1.073 kg</p>
	<p>НАИМЕН.: Штурвал в сборе с двумя кнопками (правый) НОМЕР: A32-05-0009 ВЕС: 1.073 кг</p>
	<p>NAME: Yoke assembly with two buttons (left) PART NO.: A32-05-0010 WEIGHT: 1.070 kg</p>
	<p>НАИМЕН.: Штурвал в сборе с двумя кнопками (левый) НОМЕР: A32-05-0010 ВЕС: 1.070 кг</p>





	<p>NAME: Yoke supports (nylon) PART NO.: A32-05-0011 WEIGHT: 0.082 kg</p>
	<p>NAME: Yoke supports (fluoroplast) PART NO.: A32-05-0012 WEIGHT: 0.084 kg</p>
	<p>NAME: Neutral stop support PART NO.: A32-05-0013 WEIGHT: 0.018 kg</p>
	<p>NAME: Yoke neutral stop PART NO.: A22LS-05-0011 WEIGHT: 0.021 kg</p>
	<p>НАИМЕН.: Фиксатор нейтралн штурвалов НОМЕР: A22LS-05-0011 ВЕС: 0.021 кг</p>

	<p>NAME: Handle (1pc.) for I(Y)-stick, yoke, flap lever PART NO.: A22LS-05-0012 WEIGHT: 0.009 kg</p>
	<p>НАИМЕН.: Рукоятка (1шт) для I-ручки, штурвалов, рычага закрылков НОМЕР: A22LS-05-0012 ВЕС: 0.009 кг</p>
	<p>NAME: Ø16x17 handle for control levers of trim tab, choke, parking brake PART NO.: A22LS-05-0014 WEIGHT: 0.003 kg</p>
	<p>НАИМЕН.: Рукоятка Ø16x17 рычагов триммера, обогатителя, стояночного тормоза НОМЕР: A22LS-05-0014 ВЕС: 0.003 кг</p>
	<p>NAME: Ø30x43 handle of throttle lever (yoke) right PART NO.: A32-05-0014 WEIGHT: 0.028 kg</p>
	<p>НАИМЕН.: Рукоятка Ø30x43 рычага управления двигателем (штурвал) правая НОМЕР: A32-05-0014 ВЕС: 0.028 кг</p>
	<p>NAME: Ø30x43 handle of throttle lever (yoke) left PART NO.: A32-05-0015 WEIGHT: 0.011 kg</p>
	<p>НАИМЕН.: Рукоятка Ø30x15 рычага управления двигателем (штурвал) левая НОМЕР: A32-05-0015 ВЕС: 0.011 кг</p>

	<p>NAME: \varnothing22x25 handle for brake lever (yoke) PART NO.: A22LS-05-0016 WEIGHT: 0.008 kg</p>
	<p>НАИМЕН.: Рукоятка \varnothing22x25 рычага тормоза (штурвал) НОМЕР: A22LS-05-0016 ВЕС: 0.008 кг</p>
	<p>NAME: Plug \varnothing17.5mm, blind PART NO.: A22LS-05-0020 WEIGHT: 0.003 kg</p>
	<p>НАИМЕН.: Заглушка \varnothing17.5мм глухая НОМЕР: A22LS-05-0020 ВЕС: 0.003 кг</p>
	<p>NAME: Plug \varnothing17.5mm, for button PART NO.: A22LS-05-0021 WEIGHT: 0.002 kg</p>
	<p>НАИМЕН.: Заглушка \varnothing17.5мм под кнопку НОМЕР: A22LS-05-0021 ВЕС: 0.002 кг</p>
	<p>NAME: Yoke covers set PART NO.: A22LS-05-0022 WEIGHT: 0.051 kg</p>
	<p>НАИМЕН.: Комплект накладок штурвала НОМЕР: A22LS-05-0022 ВЕС: 0.051 кг</p>





	<p>NAME: Throttle control rod assembly PART NO.: A32-05-0016 R A32-05-0016 L WEIGHT: 0.268 kg</p>
	<p>НАИМЕН.: Шток управления двигателем в сборе НОМЕР: A32-05-0016 R A32-05-0016 L ВЕС: 0.268 кг</p>
	<p>NAME: Throttle control rod pads kit PART NO.: A32-05-0017 R A32-05-0017 L WEIGHT: 0.024 kg</p>
	<p>НАИМЕН.: Комплект накладок штока управления двигателем НОМЕР: A32-05-0017 R A32-05-0017 L ВЕС: 0.024 кг</p>



Aileron control system / Система управления элеронами

	<p>NAME: Closing link L=630 mm PART NO.: A32-05-1000 WEIGHT: 0.135 kg</p>
	<p>НАИМЕН.: Тяга замыкающая L=630 мм НОМЕР: A32-05-1000 ВЕС: 0.135 кг</p>
	<p>NAME: Flaperon cables, yokes (a set) PART NO.: A32-05-1001 WEIGHT: 0.269 kg</p>
	<p>НАИМЕН.: Троса управления флаперонами, штурвал (комплект) НОМЕР: A32-05-1001 ВЕС: 0.269 кг</p>
	<p>NAME: Flaperon cables, stick (a set) PART NO.: A32-05-1002 WEIGHT: 0.235 kg</p>
	<p>НАИМЕН.: Троса управления флаперонами, ручка (комплект) НОМЕР: A32-05-1002 ВЕС: 0.235 кг</p>
	<p>NAME: Aileron control system pulley PART NO.: A32-05-1003 WEIGHT: 0.038 kg</p>
	<p>НАИМЕН.: Ролик системы управления элеронами НОМЕР: A32-05-1003 ВЕС: 0.038 кг</p>

	<p>NAME: Flap extension lever stop PART NO.: A32-05-1004 WEIGHT: 0.057 kg</p>
	<p>НАИМЕН.: Фиксатор рычага закрылков НОМЕР: A32-05-1004 ВЕС: 0.057 кг</p>
	<p>NAME: Flap extension lever stop with fasteners PART NO.: A32-05-1005 WEIGHT: 0.058 kg</p>
	<p>НАИМЕН.: Ограничитель рычага закрылков с крепежом НОМЕР: A32-05-1005 ВЕС: 0.058 кг</p>

Elevator control system / Система управления РВ

	<p>NAME: Stabilator push pull rod PART NO.: A32-05-2000 WEIGHT: 0.267 kg</p>
	<p>НАИМЕН.: Тяга управления ЦПГО НОМЕР: A32-05-2000 ВЕС: 0.267 кг</p>
	<p>NAME: Stabilator cables, yokes (a set) PART NO.: A32-05-2001 WEIGHT: 0.738 kg</p>
	<p>НАИМЕН.: Троса управления ЦПГО, штурвал (комплект) НОМЕР: A32-05-2001 ВЕС: 0.738 кг</p>
	<p>NAME: Stabilator cables, stick (a set) PART NO.: A32-05-2002 WEIGHT: 0.662 kg</p>
	<p>НАИМЕН.: Троса управления ЦПГО, ручка (комплект) НОМЕР: A32-05-2002 ВЕС: 0.662 кг</p>
	<p>NAME: Stabilator control system pulley with bearing PART NO.: A32-05-2003 WEIGHT: 0.027 kg</p>
	<p>НАИМЕН.: Ролик системы управления ЦПГО с втулкой НОМЕР: A32-05-2003 ВЕС: 0.027 кг</p>

	<p>NAME: Trim tab cables (set) PART NO.: A32-05-2004 WEIGHT: 0.092 kg</p>
	<p>НАИМЕН.: Троса триммера (комплект) НОМЕР: A32-05-2004 ВЕС: 0.092 кг</p>
	<p>NAME: Trim tab pushrod PART NO.: A32-05-2005 WEIGHT: 0.051 kg</p>
	<p>НАИМЕН.: Тяга триммера НОМЕР: A32-05-2005 ВЕС: 0.051 кг</p>
	<p>NAME: Trim tab pushrod spacers with fasteners PART NO.: A32-05-2006 WEIGHT: 0.012 kg</p>
	<p>НАИМЕН.: Распорные втулки тяги триммера с крепежом НОМЕР: A32-05-2006 ВЕС: 0.012 кг</p>

Rudder control system / Система управления РН

	<p>NAME: Rudder control cables (a set) PART NO.: A32-05-3000 WEIGHT: 0.421 kg</p>
	<p>НАИМЕН.: Троса управления руля направления (комплект) НОМЕР: A32-05-3000 ВЕС: 0.421 кг</p>
	<p>NAME: Rudder pedals bungees (a set) PART NO.: A32-05-3001 WEIGHT: 0.096 kg</p>
	<p>НАИМЕН.: Загрузатель педалей (комплект) НОМЕР: A32-05-3001 ВЕС: 0.096 кг</p>
	<p>NAME: Rudder control system pulley with bearing PART NO.: A22LS-05-3008 WEIGHT: 0.025 kg</p>
	<p>НАИМЕН.: Ролик системы управления РН с втулкой НОМЕР: A22LS-05-3008 ВЕС: 0.025 кг</p>

Autopilot / Автопилот

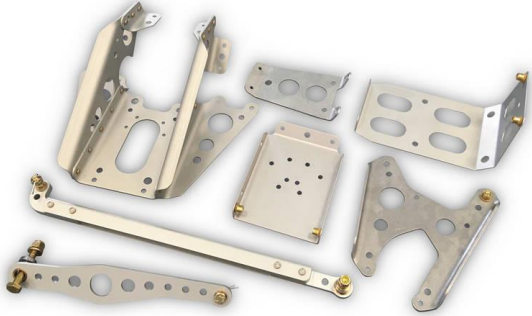



	<p>NAME: Dynon autopilot installation set PART NO.: A32-05-4000 WEIGHT: 0.629 kg</p>
	<p>НАИМЕН.: Комплект для установки автопилота Dynon НОМЕР: A32-05-4000 ВЕС: 0.629 кг</p>

06. ELECTRICAL SYSTEM / ЭЛЕКТРОСИСТЕМА**Electrical equipment / Электрооборудование**

	<p>NAME: GR-40X landing light (a set for T1110 light replacement) PART NO.: A22LS-06-0001 WEIGHT: 0.438 kg</p>
	<p>НАИМЕН.: Посадочная фара GR-40X (комплект для замены фары T1110) НОМЕР: A22LS-06-0001 ВЕС: 0.438 кг</p>
	<p>NAME: Condenser 22000 µF 25V PART NO.: A22LS-06-0002 WEIGHT: 0.093 kg</p>
	<p>НАИМЕН.: Конденсатор 22000мкФ 25В НОМЕР: A22LS-06-0002 ВЕС: 0.093 кг</p>
	<p>NAME: Switch guard PART NO.: A22LS-06-0003 WEIGHT: 0.005 kg</p>
	<p>НАИМЕН.: Защитная планка НОМЕР: A22LS-06-0003 ВЕС: 0.005 кг</p>
	<p>NAME: Toggle switch PART NO.: A22LS-06-0004 WEIGHT: 0.021 kg</p>
	<p>НАИМЕН.: Тумблер НОМЕР: A22LS-06-0004 ВЕС: 0.021 кг</p>

	<p>NAME: Battery straps (a set) PART NO.: A22LS-06-0005 WEIGHT: 0.024 kg</p>
	<p>НАИМЕН.: Ремни аккумулятора (комплект) НОМЕР: A22LS-06-0005 ВЕС: 0.024 кг</p>
	<p>NAME: Li-Ion battery strap PART NO.: A22LS-06-0007 WEIGHT: 0.012 kg</p>
	<p>НАИМЕН.: Ремень Li-Ion аккумулятора НОМЕР: A22LS-06-0007 ВЕС: 0.012 кг</p>
	<p>NAME: Fuel level sensor sealing ring PART NO.: A22LS-06-0006 WEIGHT: 0.009 kg</p>
	<p>НАИМЕН.: Уплотнение датчика уровня топлива НОМЕР: A22LS-06-0006 ВЕС: 0.009 кг</p>

Instruments / Приборное оборудование

	<p>NAME: Airspeed indicator (specify the model by the serial number of the aircraft), range: 0-240 kph, size: 3-1/8" (range markings not included) PART NO.: A22LS-06-1000 WEIGHT: 0.29 kg</p> <p>НАИМЕН.: Указатель скорости (модель уточняйте по серийному номеру самолёта), диапазон: 0-240 км/ч, размер: Ø80 мм (без маркировки диапазона) НОМЕР: A22LS-06-1000 ВЕС: 0.29 кг</p>
	<p>NAME: Airspeed indicator (specify the model by the serial number of the aircraft), range: 20-140 knots, size: 3-1/8" (range markings not included) PART NO.: A22LS-06-1001 WEIGHT: 0.37 kg</p> <p>НАИМЕН.: Указатель скорости (модель уточняйте по серийному номеру самолёта), диапазон: 20-140 узлов, размер: Ø80 мм (без маркировки диапазона) НОМЕР: A22LS-06-1001 ВЕС: 0.37 кг</p>
	<p>NAME: Altimeter (specify the model by the serial number of the aircraft), range: 20000 feet, mbar, size: 3-1/8" PART NO.: A22LS-06-1002 WEIGHT: 0.525 kg</p> <p>НАИМЕН.: Высотомер (модель уточняйте по серийному номеру самолёта), диапазон: 20000 футов, мбар, размер: Ø80 мм НОМЕР: A22LS-06-1002 ВЕС: 0.525 кг</p>
	<p>NAME: Vertical speed indicator (specify the model by the serial number of the aircraft), range: +/-2000 feet/min, size: 3-1/8" PART NO.: A22LS-06-1003 WEIGHT: 0.343 kg</p> <p>НАИМЕН.: Вариометр (модель уточняйте по серийному номеру самолёта), диапазон: +/-2000 футов/мин, размер: Ø80 мм НОМЕР: A22LS-06-1003 ВЕС: 0.343 кг</p>

	<p>NAME: Compass, size: 2-1/4" PART NO.: A22LS-06-1004 WEIGHT: 0.27 kg</p>
	<p>NAME: Compass PART NO.: A22LS-06-1005 WEIGHT: 0.3 kg</p>
	<p>NAME: Slip indicator Winter QM II PART NO.: A22LS-06-1008 WEIGHT: 0.045 kg</p>
	<p>NAME: Fuel level indicator (specify the model by the serial number of the aircraft), size: 2-1/16" PART NO.: A22LS-06-1007 WEIGHT: 0.1 kg</p>
	<p>НАИМЕН.: Индикатор уровня топлива (модель уточняйте по серийному номеру самолёта), размер: Ø52 мм НОМЕР: A22LS-06-1007 ВЕС: 0.1 кг</p>

07. СОСКРИТ EQUIPMENT / ОБОРУДОВАНИЕ КАБИНЫ

Seats / Сиденья





	<p>NAME: Standard seat assembly PART NO.: A32-07-0004 WEIGHT: 2.7 kg</p>
	<p>НАИМЕН.: Сиденье стандартное в сборе НОМЕР: A32-07-0004 ВЕС: 2.7 кг</p>
	<p>NAME: Standard seat framework PART NO.: A32-07-0002 WEIGHT: 1.708 kg</p>
	<p>НАИМЕН.: Каркас сиденья стандартного НОМЕР: A32-07-0002 ВЕС: 1.708 кг</p>
	<p>NAME: Standard seat cushion PART NO.: A32-07-0003 WEIGHT: 0.992 kg</p>
	<p>НАИМЕН.: Подушка сиденья стандартного НОМЕР: A32-07-0003 ВЕС: 0.992 кг</p>
	<p>NAME: Tall pilot seat assembly PART NO.: A32-07-0005 WEIGHT: 3.23 kg</p>
	<p>НАИМЕН.: Сиденье для высокого пилота в сборе НОМЕР: A32-07-0005 ВЕС: 3.23 кг</p>



	<p>NAME: Tall pilot seat framework PART NO.: A32-07-0006 WEIGHT: 2.14 kg</p>
	<p>НАИМЕН.: Каркас сиденья для высокого пилота НОМЕР: A32-07-0006 ВЕС: 2.14 кг</p>
	<p>NAME: Tall pilot seat cushion PART NO.: A32-07-0007 WEIGHT: 1.09 kg</p>
	<p>НАИМЕН.: Подушка сиденья для высокого пилота НОМЕР: A32-07-0007 ВЕС: 1.09 кг</p>

Harness belts / Привязная система

	<p>NAME: Harness belts (a set for 2 pilots) PART NO.: A32-07-1000 WEIGHT: 1.3 kg</p>
	<p>НАИМЕН.: Привязные ремни (комплект для 2-х пилотов) НОМЕР: A32-07-1000 ВЕС: 1.3 кг</p>

08. CONSUMABLE MATERIALS / РАСХОДНЫЕ МАТЕРИАЛЫ

	<p>NAME: ATF hydraulic fluid, 5 l PART NO.: A22LS-08-0001 WEIGHT: 4.5 kg</p> <hr/> <p>НАИМЕН.: Жидкость гидравлическая ATF, 5 л НОМЕР: A22LS-08-0001 ВЕС: 4.5 кг</p>
	<p>NAME: Mobil 1 (5W-50) engine oil, 4 l PART NO.: A22LS-08-0002 WEIGHT: 3.6 kg</p> <hr/> <p>НАИМЕН.: Моторное масло Mobil 1 (5W-50), 4 л НОМЕР: A22LS-08-0002 ВЕС: 3.6 кг</p>
	<p>NAME: Mobil antifreeze (concentrated), 5 l PART NO.: A22LS-08-0003 WEIGHT: 5.5 kg</p> <hr/> <p>НАИМЕН.: Антифриз Mobil (концентрат), 5 л НОМЕР: A22LS-08-0003 ВЕС: 5.5 кг</p>
	<p>NAME: 3M polyurethane sealant, 310 ml PART NO.: A22LS-08-1000 WEIGHT: 0.35 kg</p> <hr/> <p>НАИМЕН.: Герметик полиуретановый 3М, 310 мл НОМЕР: A22LS-08-1000 ВЕС: 0.35 кг</p>

	<p>NAME: Acrylic sealant for glazing PART NO.: A22LS-08-1001 WEIGHT: 0.3 kg</p>
	<p>НАИМЕН.: Герметик акриловый для уплотнения остекления НОМЕР: A22LS-08-1001 ВЕС: 0.3 кг</p>
	<p>NAME: Terostat-8517H primer, 25 ml PART NO.: A22LS-08-2000 WEIGHT: 0.06 kg</p>
	<p>NAME: Glasurit primer, 0.5 l + 1.0 l PART NO.: A22LS-08-2001 WEIGHT: 1.75 kg</p>
	<p>НАИМЕН.: Грунт Terostat - 8517H, 25 мл НОМЕР: A22LS-08-2000 ВЕС: 0.06 кг</p>
	<p>NAME: EcoFill primer, 3.8 l PART NO.: A22LS-08-2002 WEIGHT: 4.9 kg</p>
	<p>НАИМЕН.: Грунт Glasurit, 0.5 л + 1.0 л НОМЕР: A22LS-08-2001 ВЕС: 1.75 кг</p>
	<p>NAME: EcoFill primer, 3.8 l PART NO.: A22LS-08-2002 WEIGHT: 4.9 kg</p>
	<p>НАИМЕН.: Грунт EcoFill, 3.8 л НОМЕР: A22LS-08-2002 ВЕС: 4.9 кг</p>

CATALOG STRUCTURE / СТРУКТУРА КАТАЛОГА**A32 (A32L)****01 - AIRFRAME / ПЛАНЕР**

- 0001 - 0999 - **Fuselage** / Фюзеляж
- 1000 - 1999 - **Wing** / Крыло
- 2000 - 2999 - **Horizontal empennage** / Горизонтальное оперение
- 3000 - 3999 - **Vertical empennage** / Вертикальное оперение
- 4000 - 4999 - **Glass** / Остекление
- 5000 - 5999 - **Doors** / Двери

02 - LANDING GEAR / ШАССИ

- 0001 - 0999 - **Nose leg** / Передняя стойка
- 1000 - 1999 - **Main leg** / Основная стойка
- 2000 - 2999 - **Fairings** / Обтекатели
- 3000 - 3999 - **Mud-screens** / Щитки
- 4000 - 4999 - **Wheels** / Колеса
- 5000 - 5999 - **Brakes** / Тормоза

03 - ENGINE AND ITS SYSTEMS / ДВИГАТЕЛЬ И ЕГО СИСТЕМЫ

- 0001 - 0999 - **Engine mount** / Моторама
- 1000 - 1999 - **Control system** / Система управления
- 2000 - 2999 - **Fuel system** / Топливная система
- 3000 - 3999 - **Oil system** / Маслосистема
- 4000 - 4999 - **Cooling system** / Система охлаждения
- 5000 - 5999 - **Exhaust system** / Выхлопная система

04 - PROPELLER / ВОЗДУШНЫЙ ВИНТ

- 0001 - 0999 - **Spinner** / Кок
- 1000 - 1999 - **Propeller** / Винт

05 - AIRPLANE CONTROL SYSTEM / СИСТЕМА УПРАВЛЕНИЯ САМОЛЕТОМ

- 0001 - 0999 - **Control system levers** / Посты системы управления
- 1000 - 1999 - **Aileron control system** / Система управления элеронами
- 2000 - 2999 - **Elevator control system** / Система управления РУ
- 3000 - 3999 - **Rudder control system** / Система управления РН
- 4000 - 4999 - **Autopilot** / Автопилот

06 - ELECTRICAL SYSTEM / ЭЛЕКТРОСИСТЕМА

- 0001 - 0999 - **Electrical equipment** / Электрооборудование
- 1000 - 1999 - **Instruments** / Приборное оборудование

07 - COCKPIT EQUIPMENT / ОБОРУДОВАНИЕ КАБИНЫ

- 0001 - 0999 - **Seats** / Сиденья
- 1000 - 1999 - **Harness belts** / Привязная система
- 2000 - 2999 - **Heating** / Отопление
- 3000 - 3999 - **Instrument compartment** / Приборный отсек
- 4000 - 4999 - **Interior and baggage compartment** / Интерьер и багажник
- 5000 - 5999 - **Rescue system** / Спассистема

08 - CONSUMABLE MATERIALS / РАСХОДНЫЕ МАТЕРИАЛЫ

- 0001 - 0999 - **Oils and fluids** / Масла и жидкости систем
- 1000 - 1999 - **Sealants** / Герметики
- 2000 - 2999 - **Primers and paints** / Грунты и краски